

# NDOGO 48

Montaje Mounting	En superficie On surface
Potencia Power	8 W/m
Tensión nominal Rated voltage	24 V DC.
Temperatura de color <sup>[1]</sup> Color temperature <sup>[1]</sup>	2700°K   3000°K   4000°K
Flujo luminoso <sup>[2]</sup> Luminous flux <sup>[2]</sup>	170 lm   170 lm   210 lm
Eficiencia Efficiency	87 lm/W   90 lm/W   94 lm/W
Ángulo de apertura Beam angle	120°
Índice de reproducción cromática CRI	>90
Protección IP IP Protection	IP65
Material Material	Silicona Silicone
Dimensiones Dimensions	04 x 08 mm
Regulación Dimming	No No
Longitud de corte min. Min. cuttable length	50 mm
Diámetro de curva Bend diameter	120 mm min
Numero LEDs/metro Number of LEDs/meter	280
Carrete Estandar Standard reel	5 m
Resistente al agua salada Saltwater resistant	Si Yes
Resistente a rayos UV UV resistant	Si Yes



CRI >90

SIDE VIEW

LIGHT UNIFORM

8 W/m

30.000 h

24 V DC

IP65

## MEICON®

### DIMENSIONES Y ÓPTICA DIMENSIONS AND OPTICS

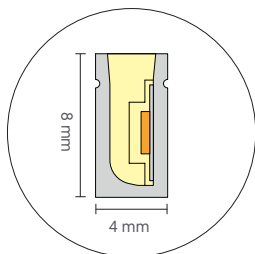

### CURVATURA BENDING

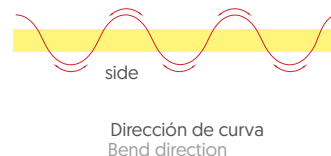

### DIMENSIONES Y DIRECCIONES DIMENSIONS AND DIRECTIONS

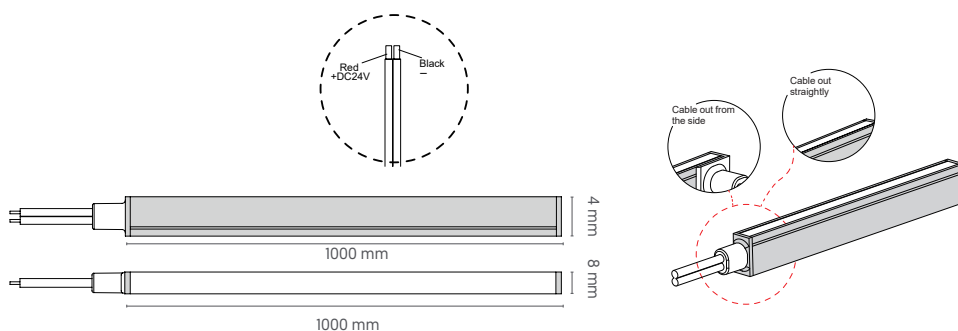

\*Las imágenes son ilustrativas. Los productos finales están sujetos a cambios sin aviso previo. \*Images for reference only. Subject to changes without prior notice.

<sup>[1]</sup> Precisión de medición para flujo +/- 5%. Precisión de medición para x, y +/- 0,005. Precisión de medición para CRI 1,5.  
Measurement precision for flux +/- 5%. Measurement precision for x, y +/- 0,005. Measurement precision for CRI 1,5.

<sup>[2]</sup> Disponibles otras temperaturas de color bajo pedido. Other colour temperatures available under request.

### CERTIFICACIONES CERTIFICATIONS

CE LM80 RÖHS

### RESISTENCIA RESISTANT



## TAMAÑO TAPAS CAP SIZE

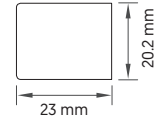
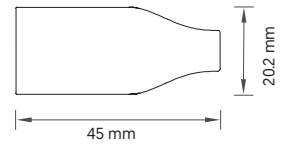
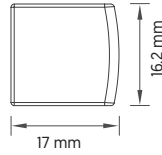
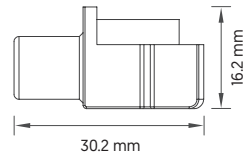
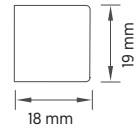
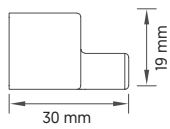

## TECNOLOGÍA IP IP PROCESS TECHNOLOGY

### SILICONA GLUE PROCESS (IP67)

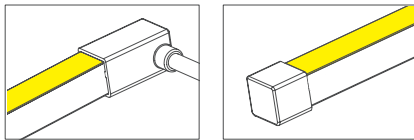

DIRECCIÓN DE SALIDA OUTLET DIRECTION

Recto / Izquierda / Derecha / Abajo  
Straight / Left / Right / Bottom

### MOLDEADO MOLDING PRESSED (IP67)

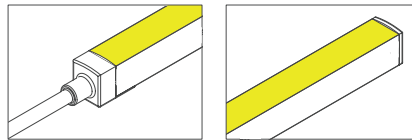

DIRECCIÓN DE SALIDA OUTLET DIRECTION

Recto / Izquierda / Derecha / Abajo  
Straight / Left / Right / Bottom

### MOLDEADO MOLDING PRESSED (IP68)

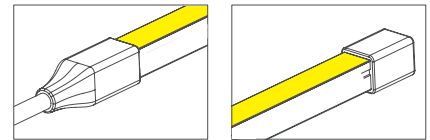

DIRECCIÓN DE SALIDA OUTLET DIRECTION

Recto  
Straight

## ACCESORIOS ACCESORIES



TAPA CABLE  
CABLE CAP



SILICONA  
SILICONE



CARRIL DE ALUMINIO  
ALUMINUM RAIL



TAPA CABLE 90°  
CABLE CAP 90°



TAPA CIEGA  
END CAP



TORNILLOS  
SCREWS



TAPA CIEGA  
END CAP



TAPA CABLE  
CABLE CAP



DMX 512 CONTROLER  
DMX 512 CONTROLER



TAPA CABLE  
CABLE CAP



TAPA CIEGA  
END CAP



SNAKE



3,5cm CLIP ALUMINIO  
3,5cm ALUMINUM CLIP



CARRIL DE ALUMINIO  
ALUMINUM RAIL



CLIP  
SILICONE